

Z400 iQ

Instructions for installation and use - English
Heat pump
Translation of the original instructions in French

EN

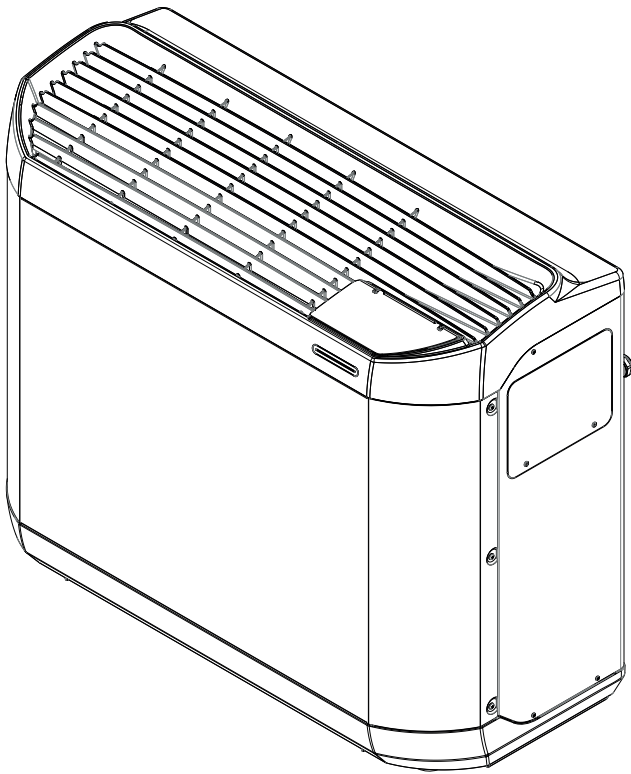

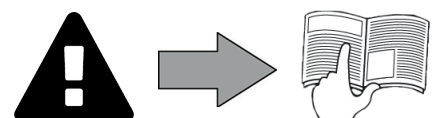

More documents on:
www.zodiac.com



WARNINGS

GENERAL WARNINGS

- Failure to respect the warnings may cause serious damage to the pool equipment or cause serious injury, even death.
- Only a person qualified in the technical fields concerned (electricity, hydraulics or refrigeration) is authorised to perform any servicing or repairs to the appliance. The qualified technician working on the appliance must use/wear personal protective equipment (such as safety goggles and protective gloves, etc.) in order to reduce the risk of injury occurring when working on the appliance.  
- Before handling the machine, ensure that the power is switched off and isolated from the power supply.
- The appliance is intended to be used for pools and spas for a specific purpose; it must not be used for any purpose other than that for which it was designed.
- This appliance can be used by children aged from 8 years and above and persons with reduced physical, sensory or mental capabilities or lack of experience and knowledge if they have been given supervision or instruction concerning use of the appliance in a safe way and understand the hazards involved.
- Keep the appliance out of the reach of children.
- Children shall not play with the appliance.
- Children should be supervised to ensure that they do not play with the appliance.
- Cleaning and user maintenance shall not be made by children without supervision.
- The appliance must be installed according to the manufacturer's instructions and in compliance with local standards. The installer is responsible for installing the appliance and for compliance with national installation regulations. Under no circumstances may the manufacturer be held liable in the event of failure to comply with applicable local installation standards.
- For any work other than the simple user maintenance described in this manual, the product should be referred to a qualified professional.
- Incorrect installation and/or use may cause serious damage to property or serious injuries (possibly causing death).
- All equipment, even postage and packing paid, travels at the risks and perils of the recipient. The latter shall issue reserves in writing on the carrier's delivery slip if damage is detected, caused during transport (confirmation to be sent to the carrier within 48 hours by registered letter). In the event that an appliance containing coolant has been turned on its side, mention your reservations in writing to the carrier.
- If the appliance suffers a malfunction, do not try to repair it yourself; instead contact a qualified technician.
- Refer to the warranty conditions for details of the permitted water balance values for operating the appliance.
- Deactivating, eliminating or by-passing any of the safety mechanisms integrated into the appliance shall automatically void the warranty, in addition to the use of spare parts manufactured by unauthorised third-party manufacturers.
- Do not spray insecticide or any other chemical (flammable or non-flammable) in the direction of the appliance, as this may damage the body and cause a fire.
- Zodiac® heat pump, filtration pump and filter appliances are compatible with the most commonly used types of pool water treatment systems.
- Do not touch the fan or moving parts and do not place any objects or your fingers in the vicinity of the moving parts during operation of the appliance. Moving parts can cause serious injury or even death.

WARNINGS ASSOCIATED WITH ELECTRICAL APPLIANCES

- The electrical supply to the appliance must be protected by a 30 mA differential Residual Current protection Device (RCD), complying with the standards and regulations in force in the country in which it is installed.
- Do not use any extension lead when connecting the appliance; connect the appliance directly to a suitable power supply circuit.
- If a stationary appliance is not fitted with a supply cord and a plug, or with other

means for disconnection from the supply mains having a contact separation in all poles that provide full disconnection under overvoltage category III conditions, the instructions shall state that means for disconnection must be incorporated in the fixed wiring in accordance with the wiring rules.

- A Suitable disconnecting means, which complies with all local and national requirements for over-voltage category III, and which disconnects all poles of the supply circuit, must be installed in the supply circuit to the appliance. Such disconnecting means is not provided with the appliance and must be provided by the installation professional.
- Before carrying out any operations, check that:
 - The voltage indicated on the appliance information plate corresponds to the mains voltage.
 - The power grid is adapted to the power requirements of the appliance, and is grounded.
 - The plug (where applicable) is suitable for the socket.
- In the event of anormal operation or the release of unusual odours from the appliance, turn it off immediately, unplug it from its power supply and contact a professional.
- Before any access to the appliance for service or maintenance, ensure that it is switched off and completely disconnected from the power supply. Furthermore, in addition to confirming that the heating priority (where applicable) is deactivated, ensure that any other equipment or accessories connected to the appliance are also disconnected from the power supply circuit.
- Do not disconnect and reconnect the appliance to the power supply when in operation.
- Do not pull on the power cord to disconnect it from the power supply.
- If the power cord is damaged, it must be replaced by the manufacturer, its technician or a qualified person to guarantee safety.
- Do not perform maintenance or servicing operations on the appliance with wet hands or if the appliance is wet.
- Before connecting the appliance to the source of supply, ensure that the terminal block or supply socket to which the appliance will be connected is in good condition and is not damaged or corroded in any way.
- For any component or sub-assembly containing a battery: do not recharge or dismantle the battery, or throw it into a fire. Do not expose it to high temperatures or direct sunlight.
- In stormy weather, disconnect the appliance from the power supply to prevent it from suffering lightning damage.
- Do not immerse the appliance in water (with the exception of cleaners) or mud.

WARNINGS CONCERNING APPLIANCES CONTAINING REFRIGERANT

- Do not release R410A or R407C fluid into the atmosphere. These are fluorinated greenhouse gases, covered by the Kyoto Protocol, with a Global Warming Potential (GWP) of 1975 for R410A or 1653 for R407C - (see Directive EC 842/2006 on fluorinated greenhouse gases).
- In order to comply with relevant environmental and installations standards and regulations such as, but not limited to, French decree No. 2015-1790 and/or the EU Regulation EU 517/2014, the cooling circuit must be checked for leakage at least once a year. This operation must be carried out by a certified cooling appliance specialist.

The heat pump pool heaters covered in this document have been evaluated, tested, and shown to comply with the applicable requirements of the following Directives:

- Pressure Equipment Directive (PED), 2014/68/EU, Module D1;
- Low Voltage Directive (LVD), 2014/35/EU;
- Electro-Magnetic Compatibility (EMC) Directive, 2014/30/EU.

The appliances have an Ingress Protection (IP) rating of IPX4 or better. Please refer to the marking indicating the IP-rating on your particular product.

Installation and maintenance

The appliance may not be installed close to combustible materials, or an air duct inlet of an adjacent building.

With some appliances, it is essential to fit protection grids if the unit is installed in an area with uncontrolled access. During installation, troubleshooting and maintenance, pipes may not be used as steps: the pipe could break under the weight, spilling coolant and possibly causing serious burns.

When servicing the appliance, the composition and state of the heat transfer fluid must be checked, as well as the absence of any traces of coolant. During the appliance's annual sealing test in accordance with applicable legislation, the high and low pressure switches must be checked to ensure that they are securely fastened to the cooling circuit and that they cut off the electrical circuit when tripped. During maintenance work, ensure there are no traces of corrosion or oil around the cooling components. Before beginning work on the cooling circuit, stop the appliance and wait for a few minutes before fitting the temperature and pressure sensors. Some elements such as the compressor and piping may reach temperatures in excess of 100°C and high pressures with the consequent risk of severe burns.

EN

Troubleshooting

All soldering work must be carried out by someone qualified to do so.

Replacement pipes must always be made of copper in compliance with standard NF EN 12735-1.

Leak detection, pressure test:

- never use oxygen or dry air (risk of fire or explosion)
- use dry nitrogen or the mixture of nitrogen and coolant indicated on the information plate,
- the test pressure for both the high and low pressure circuits must not exceed 42 bar (for R410A), 20 bar and 15 bar (for R407C) if the appliance is equipped with the optional pressure gauge.

The high pressure circuit pipes are made of copper and have a diameter equal to or greater than 1"5/8. A certificate as indicated in §2.1 in compliance with standard NF EN 10204 will be requested from the supplier and filed with the facility's technical documentation.

Technical data relative to the safety requirements of the various applicable directives are indicated on the information plate. All this information must be recorded in the appliance's installation manual, which must be kept in its technical file: model, code, serial number, maximum and minimum OT, OP, year of manufacture, CE marking, manufacturer's address, coolant and weight, electrical parameters, thermo-dynamic and acoustic performance.

Recycling



This symbol means that your appliance must not be thrown into a normal bin. It will be selectively collected for the purpose of reuse, recycling or transformation. If it contains any substances that may be harmful to the environment, these will be eliminated or neutralised. Contact your retailer for recycling information.



- Before handling the appliance, it is vital that you read this installation and user manual, as well as the "Warranty" booklet delivered with the appliance. Failure to do so may result in material damage or serious or fatal injury and will void the warranty.
- Keep and pass on these documents for later viewing throughout the appliance's service life.
- The distribution or modification of this document in any way is prohibited, without prior authorisation from Zodiac®.
- Zodiac® is constantly developing its products to improve their quality; therefore, the information contained in this document may be modified without notice.

CONTENTS



1 Installation

5

1.1 | Selecting the location

5

1.2 | Hydraulic connections

7

1.3 | Accessing the electrical connection terminal boards

8

1.4 | Power connections

8

1.5 | Connecting options

9



2 Use

11

2.1 | Operating principle

11

2.2 | User interface presentation

12

2.3 | Operation

13

2.4 | User functions

14



3 Maintenance

15

3.1 | Winterizing

15

3.2 | Maintenance

15



4 Troubleshooting

16

4.1 | Appliance behaviour

16

4.2 | Error code display

17

4.3 | Lighting of LEDs on the printed circuit board

18

4.4 | Wiring diagrams

19



5 Characteristics

24

5.1 | Description

24

5.2 | Technical specifications

25

5.3 | Dimensions and marking

25



Tip: to make it easier to contact your retailer

- Write down your retailer's contact details to help you find them more easily and fill in the "product" information on the back of the manual; your retailer will ask you for this information.



1 Installation

1.1 I Selecting the location

- When installed with and protected by an appropriate Residual Current Device (RCD) having a maximum trip current rating of 30mA, the appliance must be installed at 2 metres, minimum, from the surrounding edge of the pool.
- If an appropriate RCD is not installed with the appliance, the appliance must be installed at a minimum distance of 3.5 metres from the edge of the pool.



- Do not lift the appliance by the body; use straps (not provided, see § “1.1.1 I Setting up the device”).
- Exercise care during handling of the device. The evaporator (marking **Ⓞ** in § “5.3 I Dimensions and marking”) can be easily damaged.
- The evaporator (marking **Ⓞ** in § “5.3 I Dimensions and marking”) may contain sharp edges which can cause injury. In order to prevent any injury, wear protective gloves during servicing operations which may involve contact with the evaporator.



EN

- Only an outdoor installation is possible, provide free space around the appliance according to diagram § “1.2 I Hydraulic connections”.
- Place the appliance on its anti-vibration blocks (integrated under its base, height adjustable) on a stable, solid and level surface,
- This surface must be able to bear the weight (voir § 5.2 I “Technical specifications”) of the appliance (in particular in the case of installation on a roof, a balcony or any other support).

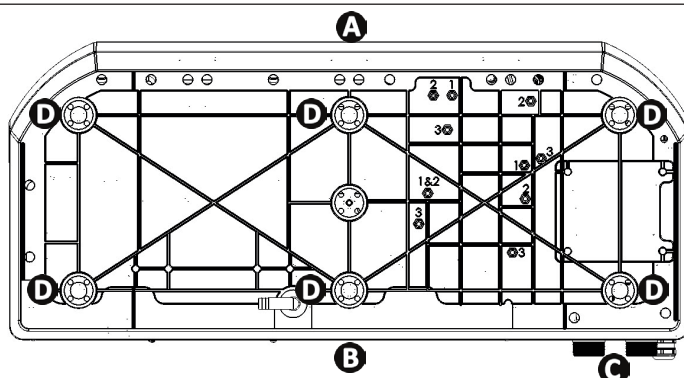

View of the appliance base from below for installing the anti-vibration blocks
(MD4 / MD5 / MD7 / TD7 models)

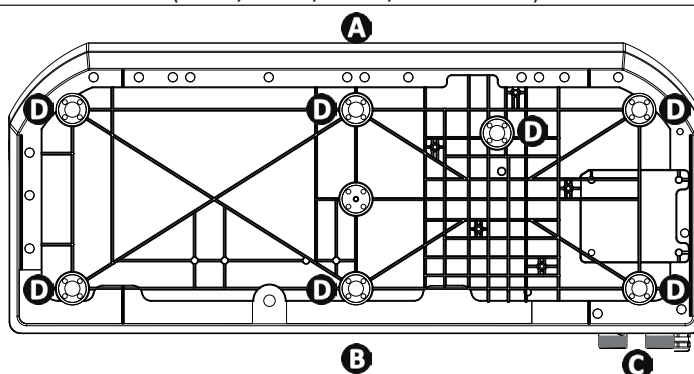

View of the appliance base from below for installing the anti-vibration blocks
(MD8 / TD8 / MD9 / TD9 models)

- A**: front
- B**: rear
- C**: connections
- D**: Anti-vibration blocks

The appliance must not be installed:

- With the blowing towards a permanent or temporary obstacle (awning, brushwood, etc.) less than 5 metres away,
- Within range of water or mud jets, sprays or run-off (take the effect of the wind into account),
- Near a heat source or flammable gas,
- Near high-frequency equipment,
- In a location where it would be subject to snow build-up,
- In a location where it might be flooded by the condensates produced by the appliance when operating.

Tip: reduce any noise annoyance from your heat pump



- Do not install it under or towards a window.
- Do not tilt it towards your neighbours.
- Install it in an open space (sound waves are reflected on surfaces).
- Install an acoustic screen around the heat pump, respecting the distances (see diagram § «1.2 | Hydraulic connections»).
- Install 50 cm of flexible PVC pipe at the heat pump water inlet and outlet to absorb vibrations.
- Increase the filtration time by 50% and activate "silence" mode. The heat pump will run for longer with less power, but much more quietly and with an improved COP (energy savings). «Silence» mode is particularly well suited for maintaining the water temperature once the setpoint temperature has been reached.

1.1.1 Setting up the device

- Use straps (not supplied) to lift the device to prevent damage during installation.

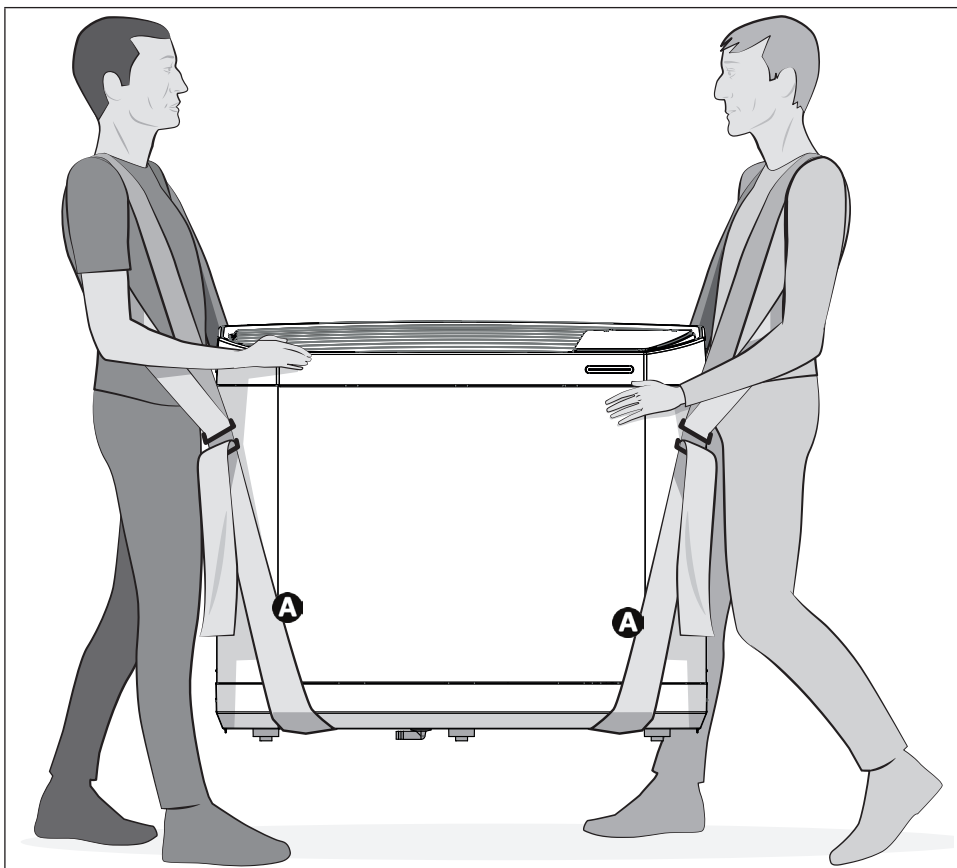

A : Strap

➤ 1.2 I Hydraulic connections

- The device will be connected with a $\varnothing 50$ PVC pipe, using the half union connectors supplied (see § “5.1 I Description”), to the pool's filtration circuit, after the filter and before the water treatment.
- Respect the direction of hydraulic connection.
- A by-pass must be installed to make it easier to work on the appliance.

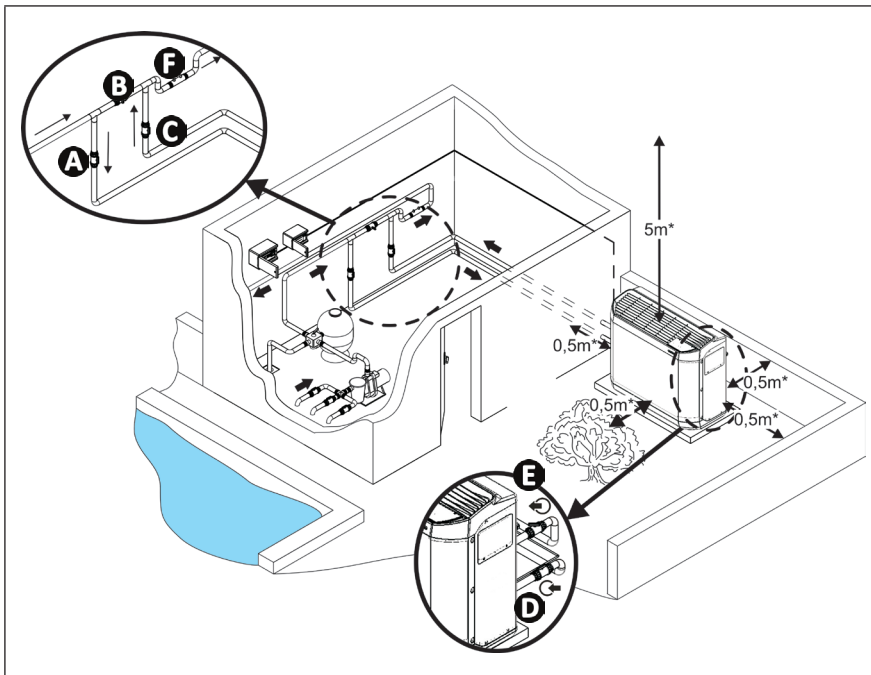

- A**: water inlet valve
- B**: by-pass valve
- C**: water outlet valve
- D**: water inlet adjustment valve (optional)
- E**: water outlet adjustment valve (optional)
- F**: water treatment
- * minimum distance

EN

- To evacuate the condensates, fit a $\varnothing 18$ pipe on the grooved elbow mounted under the appliance base.
- The elbow can be oriented at an angle of 280° beneath the appliance.

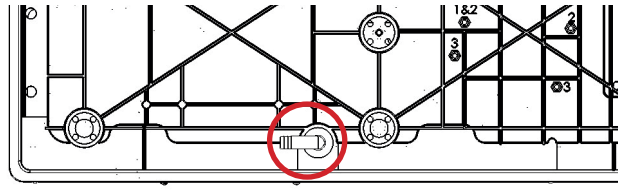

Condensate drainage elbow (view of the device from below)



Tip: condensate drainage

Caution, several litres of water can be drained from your appliance each day. We strongly recommend connecting the drain to a suitable water drainage system.

➤ 1.3 I Accessing the electrical connection terminal boards

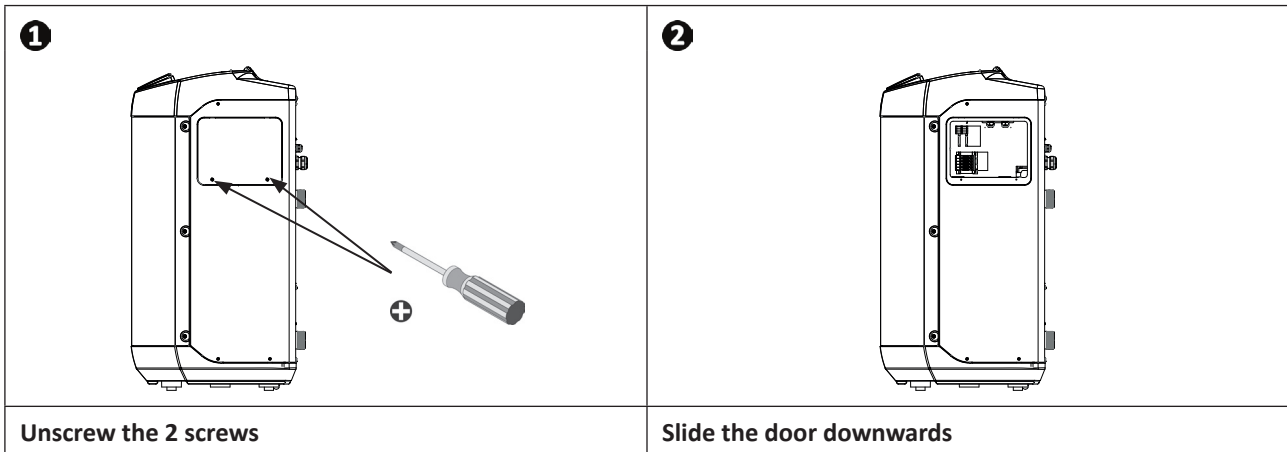

➤ 1.4 I Power connections



- Before any work inside the appliance, you must cut the electricity supply to the appliance as there is a risk of electric shock which may cause material damage, serious injury or even death.
- Incorrectly tightened terminals may cause the terminal box to heat up, which can invalidate the warranty.
- Only a qualified and experienced technician is authorised to carry out cabling work within the appliance or to replace the power cord.
- The installer must consult the electricity provided if necessary and ensure that the equipment is connected correctly to an electricity network with impedance under 0.095 ohm.

- The heat pump's electrical supply must be provided through a protection and circuit breaking device (not supplied) complying with the standards and regulations in force in the country where it is installed,
- The appliance is provided for connection to a general power supply with a TT or TN.S neutral regime.
- Electrical protection: by circuit breaker (D curve, rating to be defined according to the table § "5.2 I Technical specifications"), with a suitable dedicated differential protection device (circuit breaker or switch).
- Additional protection may be required during installation to guarantee the II overvoltage category.
- The power supply must correspond to the voltage indicated on the appliance's information plate.
- The power cord must be insulated against any cutting or hot elements that may damage or crush it.
- The appliance must be connected to an earth socket.
- The electrical connection lines must be fixed.
- Use the gland to pass the power cord into the appliance.
- Use the power cord (RO2V type) adapted for outdoor or buried use (or run the cable into a protection duct) with an external diameter of between 9 and 18mm.
- We recommend burying the cable at a depth of 50 cl (85 cm under a road or path) in an electrical duct (red ribbed).
- If this buried cable meets another cable or pipe (gas, water, etc.), there must be more than 20 cm between them.
- Connect the power supply cord to the spring-cage terminal block (see § «1.4.1 I Wiring on a spring-cage terminal block») inside the appliance.

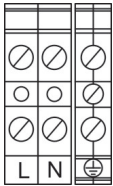
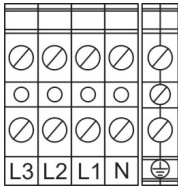
 <p>L : live N : neutral ⊕ : earth</p>		 <p>L1 - L2 - L3 : live N : neutral ⊕ : earth</p>	
<p>Connection terminal board for single-phase power</p>		<p>Connection terminal board for three-phase power</p>	

1.4.1 Wiring on a spring-cage terminal block

- Pull the lever to the maximum, then connect the cable(s) (see picture **1**).
- Return the lever to its original position (see image **2**).

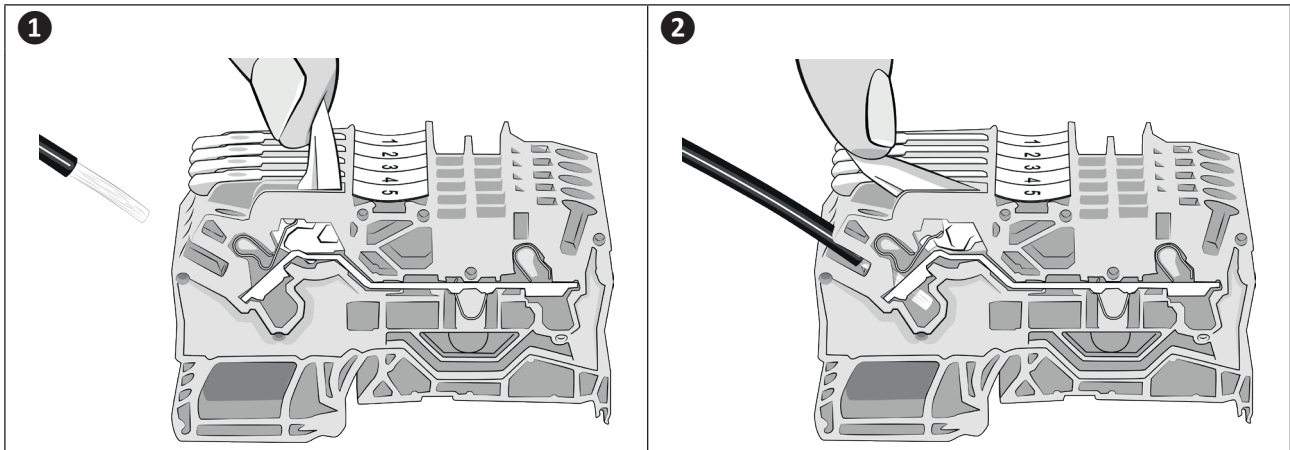

➤ 1.5 | Connecting options

Connecting the "Heating priority" and "On/off command" options:



- Before any work inside the appliance, you must cut the electricity supply to the appliance as there is a risk of electric shock which may cause material damage, serious injury or even death.
- There is a risk of electrical return current, injuries, material damage and death when working on terminals 1 to 8.
- Any connection error with terminals 1 to 8 may damage the appliance and invalidated its warranty.
- Terminals 1 to 8 are dedicated to the options and must never be used to directly supply other equipment.
- Use cables with a section of at least $2 \times 0.75 \text{ mm}^2$, RO2V type and with a diameter between 8 and 13 mm.

Before connecting any options: remove the seal (above the cable gland) and install the cable gland provided in order to pass the cables into the appliance. The cables used for the options and the power cord must be kept separate (risk of interference) using a collar inside the appliance just after the glands.

1.5.1 "Heating priority" option

- This function helps to keep the water temperature constant by checking the water temperature at regular time intervals (minimum 5 minute cycle every 120 minutes) by filtration pump control. The filtration is kept operating if the pool temperature is below the temperature requested.
- For the connection, connect the filtration timer to terminals 1 and 2 (dry contact, no polarity, maximum intensity 8A).

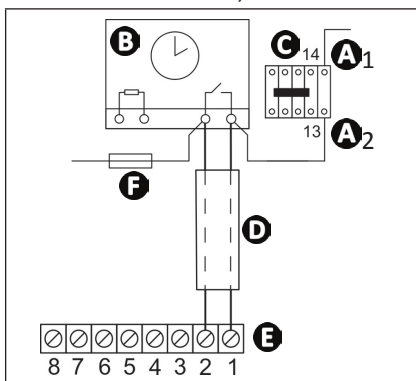

- **A1- A2:** power for the filtration pump power contactor coil
- **B:** filtration timer
- **C:** power contactor (tripolar or bipolar) for the filtration system pump motor
- **D:** separate cable for the "heating priority" function
- **E:** heat pump terminal board
- **F:** fuse

1.5.2 Remote "on/off" control option

- This option enables the "on/off" button function to be transferred via a switch or a home automation system installed remotely.
- For the connection, remove the shunt between terminals 7-8 and connect the wire of the switch in place (potential free contact, no polarity, 220-240V ~ 50Hz).

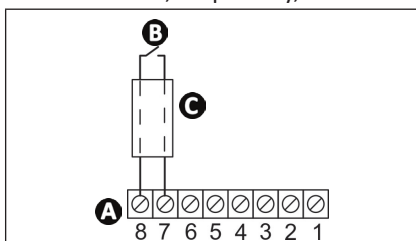

- **A:** heat pump terminal board
- **B:** remote "on/off" switch
- **C:** separate connection wire



2 Use

2.1 I Operating principle

2.1.1 General operation

Your heat pump uses the calories (heat) in the air to heat up your pool's water. The process to heat your pool's water to the temperature you want may take a few days as it depends on the weather conditions, your heat pump's power and the difference between the water temperature and the temperature you want.

The warmer and damper the air, the better your heat pump will perform. The outdoor parameters for optimum operation are an air temperature of 27°C, a water temperature of 27°C and 80% relative humidity.



Tip: improve your pool's temperature rise and maintenance

- Anticipate the commissioning of your pool far enough in advance before you use it.
- For the temperature rise, set the water circulation to continuous operation (24/24).
- To maintain the temperature throughout the season, run "automatic" circulation for at least 12 hours/day (the longer this time the longer the heat pump will have enough operating range to heat up).
- Cover the pool with a sheet (bubble canopy, canvas, etc.) to prevent heat loss.
- The heat pump will be even more efficient if it operates during the warmest hours of the day.
- Keep the evaporator clean.
- Set the temperature you want and let the heat pump run (adjusting the setpoint to maximum will not heat the water more quickly).
- Connect the "Heating priority"; the filtration pump and heat pump operating time will be set according to requirements.

EN

2.1.2 Operating modes (default settings)

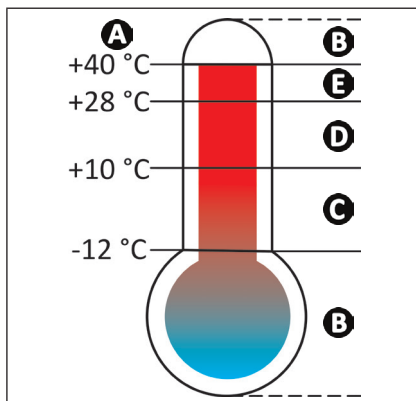

- A**: External air temperature
- B**: Heat pump shutdown, outside of operating range
- C**: Forced "Boost" mode
- D**: Possibility of selecting the "Boost" or "Silence" operating mode
- E**: Forced "Silence" mode

2.2 I User interface presentation



- To lock or to unlock the keypad: simultaneously press and for 3 seconds.

2.2.1 Presentation of the display screen and function keys

	Actual water temperature* *Displays the temperature measured during the last operation of the heat pump.
	"On/off" button Go back in the menus
	Change settings button Activate/deactivate "Silence" mode
	Value setting buttons

2.2.2 Description of the display screen

Symbol	Name	Steady	Flashing	Off
	Water flow	Water flow okay	Water flow too low or missing	Appliance switched off
	Air temperature	/	Air temperature out of operating range	Air temperature in the operating range
	"Cold" mode	"Cold" mode activated	/	"Cold" mode deactivated
	"Silence" mode	"Silence" mode activated	/	"Silence" mode deactivated

2.2.3 Description of the LEDs showing the «appliance status»

LED	Appliance status	Meaning
Steady green	OK	Temperature reached or operation in "hot" mode
Steady blue	OK	Operation in "cold" mode
Steady red	Error in progress	Error in progress, see error message on the interface and meaning (see § "4.2 I Error code display")
Flashing red	Stopped	The appliance shuts down after more than 4 errors in one hour and requires a manual restart after correcting the error (see § "4.2 I Error code display")
Off	Stopped	Device off or not connected to the power supply

2.3 I Operation

- Check that there are no tools or other foreign objects in the machine.
- The panel that provides access to the technical section (see § «5.3 I Dimensions and marking») must be put back in place.
- Set the valves as follows: valve B wide open, valves A, C, D and E closed.

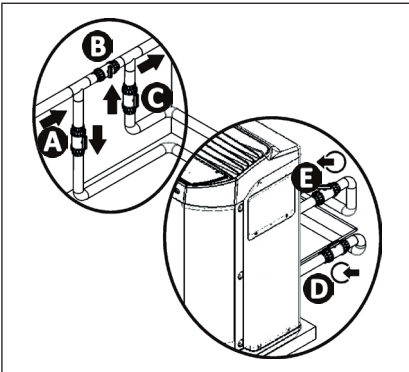

- A**: water inlet valve
- B**: by-pass valve
- C**: water outlet valve
- D**: water inlet adjustment valve (optional)
- E**: water outlet adjustment valve (optional)

EN



- **An incorrect by-pass setting may cause the heat pump to malfunction.**

- Check that the hydraulic connections are correctly tightened and that there are no leaks.
- Check that the appliance is stable.
- Turn on the water flow (by activating filtration).
- Close valve B gradually so that the filter pressure is increased by 150g (0.150 bars).
- Open valves A, C and D fully then valve E by half (the air which has built up in the heat pump condenser and the filtration circuit will bleed out). If valves D and E are not present, open valve A wide and close valve C by half.
- Connect the power supply to the heat pump.

- The heat pump is on standby

- Press for 2 seconds: (software version vary depending on the appliances) is displayed for 4 seconds,

the last water temperature measured is then displayed

This value varies depending on the last temperature recorded during the last connection.



If no water flow was present during the last connection, the screen will display the value

- Set the desired temperature (called the "temperature setpoint") (see § "2.4.2 Adjusting the temperature setpoint").

After the start-up steps for your heat pump:







- Shut down the water circulation temporarily (by stopping the filtration or closing valve B or C) to check that you appliance stops after a few seconds (via the activation of the flow switch).
- Reduce the setpoint temperature to below the water temperature to check that the heat pump stops operating.
- Switch off the heat pump by pressing and holding for 2 seconds and check that it stops.

2.4 I User functions

2.4.1 Locking/unlocking the keyboard



To lock or to unlock the keypad, press and hold  and  simultaneously for 3 seconds:  or .

2.4.2 Adjusting the temperature setpoint

- Press  or : the temperature setpoint is displayed and flashes,
 - Press  to increase the temperature by 0.5 °C*,
 - Press  to reduce the temperature by 0.5 °C**.
 - Press  to confirm the desired setpoint temperature.
 - The settings screen is automatically exited after 3 seconds of inactivity on the keypad or by pressing and releasing .
- The heat pump stops automatically when the pool reaches the required temperature.

*Maximum setpoint temperature = 32 °C.
**Minimum setpoint temperature = 15 °C.





If the setpoint temperature has not been confirmed by pressing , it will not be saved if the interface returns to the home screen (which takes place automatically after 3 seconds of inactivity on the keypad or by pressing and releasing ).

2.4.3 Activating/deactivating “silence” mode







«Silence» mode is used to reduce the noise level emitted by the heat pump.
The appliance will operate for a longer period of time with less power, however with a lower noise level.

There are 2 ways to activate the “Silence” mode:

1st method

- Press and release , the symbol  will light up.







2nd method

- Press and hold 
- Press  or  to display: .
- Press and release , the symbol  will light up.
- The home screen automatically reappears after 60 seconds of inactivity on the keypad or by pressing and releasing .

To deactivate the “Silence” mode, redo the manipulation, the symbol  will go out.

2.4.4 Activating/deactivating “cold” mode

Activation of «Cold» mode allows the machine’s cycle to be automatically reversed to cool the pool water when it exceeds the setpoint temperature by more than 2°C.

- Press and hold 
- Press  or  to display: .
- Press and release , the symbol  will light up.
- The home screen automatically reappears after 60 seconds of inactivity on the keypad or by pressing and releasing .

To deactivate the “cold/cooling” mode, redo the manipulation, the symbol  will go out.



«Cold» mode does not allow cooling to be activated manually.
For immediate activation, activate «Cold» mode then return to the main screen and lower the setpoint temperature to at least 2 degrees below the measured water temperature.



3 Maintenance

➤ 3.1 I Winterizing



- Although the device may be used year around, in the event that it will not be used during the winter months, proper winterizing is necessary in order to prevent damage to the condenser. Damage due to failure to properly winterize the unit when it is not use is not covered by the warranty.
- To prevent condensation from damaging the appliance: cover the appliance with the winterizing cover supplied (do not hermetically-seal the appliance inside a cover).

- Set the regulator to "standby" mode by pressing and holding  for 2 seconds and disconnect the power supply,
- Open valve B,
- Close valves A and C and open valves D and E (if present),
- Make sure that there is no water circulating in the heat pump,
- Drain the water from the condenser (risk of freezing) by unscrewing the two water inlet and outlet connectors on the back of the heat pump,
- In the case of full winterizing for the pool (complete shutdown of the filtration system, bleed the filtration circuit or even pool drainage): tighten the two connectors by one turn to prevent any foreign bodies from getting into the condenser,
- In the case of winterizing for the heat pump only (shutdown of the heating only, the filtration keeps running): to not tighten the connectors but add 2 caps (provided) on the condenser's water inlets and outlets.
- We recommend that you put the aired winterizing micro cover (provided) on the heat pump.

➤ 3.2 I Maintenance



- Before performing any maintenance operation on the appliance, you must cut the electricity supply as there is a risk of electric shock which may cause material damage, serious injury or even death.
- It is recommended that the appliance undergo general servicing at least on a yearly basis to ensure proper operation, maintain performance levels and potentially prevent certain failures. These operations are carried out at the user's expense by a qualified technician.

3.2.1 User maintenance

- Make sure that the ventilation grid is not blocked by any foreign bodies.
- Clean the evaporator (for location see § "5.3 I Dimensions and marking") using a soft brush and a fresh water spray (disconnect the power cable); do not fold over the metal wings, then clean the condensate drainage line to remove any impurities that may be blocking it.
- Do not use a high pressure jet. Do not spray with rain water, salt water or water which is full of minerals.
- Clean the outside of the appliance using a solvent-free product; a specific «PAC NET» cleaning kit is available as an accessory in the Zodiac catalogue for this purpose (see § "5.1 I Description").

3.2.2 Maintenance to be carried out by a qualified technician

- Check that the control system is operating correctly.
- Check that the condensates flow correctly when the appliance is in operation.
- Check the safety mechanisms.
- Check the connection of the metal masses to the earth.
- Check that the electrical cables are correctly tightened and connected and that the switch box is clean.



4 Troubleshooting























- If a problem occurs, before you contact your retailer, please carry out these few simple checks using the following tables.
- If the problem continues, contact your retailer.
- : Actions to be performed by a qualified technician only

4.1 I Appliance behaviour

The appliance does not start heating straight away	<ul style="list-style-type: none"> • When the setpoint temperature is reached, the heat pump stops heating: the water temperature is higher than or equal to the setpoint temperature. • When the water flow rate is zero or is not enough, the heat pump stops: check that the water is circulating correctly in the heat pump (see § "2.2 I User interface presentation") and that the hydraulic connections are correct. • The heat pump stops when the outdoor temperature falls below -12 °C. • It may be that the heat pump has detected an operating fault (see § "4.2 I Error code display"). • If you have checked these points and the problem persists: contact your retailer.
The appliance is discharging water	<ul style="list-style-type: none"> • Often called condensates. This water is the moisture contained in the air which condenses on contact with certain cold mechanisms in the heat pump, especially on the evaporator. The damper the air, the more condensates your heat pump will produce (your appliance may drain several litres of water per day). This water is retrieved by the base of the heat pump and drained by the condensate drainage elbow (see § "1.2 I Hydraulic connections"). • To check that the water is not coming from a leak in the pool circuit on the heat pump, shut down the heat pump and run the filtration pump for the water to circulate in the heat pump. If the water continues to flow through the condensate drainage lines, there is a water leak in the heat pump; contact your retailer.
The evaporator is iced over	<ul style="list-style-type: none"> • Your heat pump will soon switch to its defrost cycle to melt the ice. • If your heat pump cannot manage to defrost its evaporator, it will stop itself; this means that the outdoor temperature is too low (below -12 °C).
The appliance is "smoking"	<ul style="list-style-type: none"> • The machine has come to the end of the defrost cycle; water has changed to gaseous state and passes through the grid. • If your heat pump is not in its defrost cycle, this is not normal. Switch off and disconnect the heat pump immediately and contact your retailer.
The appliance is not working	<ul style="list-style-type: none"> • If there is no display, check the supply voltage and the F2 fuse. • When the setpoint temperature is reached, the heat pump stops heating: the water temperature is higher than or equal to the setpoint temperature. • When the water flow rate is zero or is not enough, the heat pump stops: check that the water is circulating correctly in the heat pump (see § "2.2 I User interface presentation"). • The heat pump stops when the outdoor temperature falls below -12 °C or rises above +40 °C. • It may be that the heat pump has detected an operating fault (see § "4.2 I Error code display").
The appliance is working but the water temperature does not increase	<ul style="list-style-type: none"> • Check that the automatic water filling controller (see diagram in § «2.3 I Operation») is not stuck in the open position: this will keep supplying cold water into the pool and will prevent the temperature from rising. • There is too much heat loss. Install a heat insulated cover on your pool. • The heat pump is unable to capture enough calories as its evaporator is clogged with dirt. Clean it to restore its performances (see § "3.2 I Maintenance"). • Check that the external environment is not hindering the heat pump (see § "1 Installation"). • Check that the heat pump is the right size for this pool and its environment.
The fan is running but the compressor stops from time to time with no error message	<ul style="list-style-type: none"> • If the outdoor temperature is low, the heat pump performs defrost cycles under normal operation. • The heat pump is unable to capture enough calories as its evaporator is clogged with dirt. Clean it to restore its performances (see § "3.2 I Maintenance").
The appliance trips the circuit breaker	<ul style="list-style-type: none"> • Check that the circuit breaker is correctly dimensioned and that the cable section used is appropriate (see § "5.2 I Technical specifications"). • The supply voltage is too low: contact your electricity supplier.

4.2 I Error code display

Display of	Possible causes	Solutions	Reset
E01 Exchanger protection in "cooling" mode	ST4 sensor temperature too low	Wait until the exterior temperature rises	Automatic
E02 High temperature error on evaporator in "cooling" mode	ST3 sensor temperature over 60°C or evaporator scaled up	Clean the evaporator, if problem persists, call a qualified technician	Automatic if ST3 sensor temperature below 45 °C
E03 Phase order fault (on three phase models only)	Cabling not respected on the appliance's supply terminals,	 Invert phases on power terminals (appliance switched off)	By electricity supply disconnection or by pressing 
	Electricity provider has changed the order of the phases	Contact the electricity provided to find out if your installation has been modified.	
	Temporary disconnection of the power supply to one or more phases		
E04 Cooling circuit low pressure fault	Pressure fault in the low pressure circuit (if problem persists after resetting)	Call a qualified technician	<ul style="list-style-type: none"> • «Steady red» LED = automatic • «Flashing red» LED = press 
E05 Cooling circuit high pressure fault	Exchanger clogged with dirt	 Clean the water exchanger	<ul style="list-style-type: none"> • «Steady red» LED = automatic • «Flashing red» LED = press 
	Insufficient water flow	 Increase flow using the bypass, check that the pool filter is not clogged	
	Air and water emulsion has passed into the appliance	 Check the pool's hydraulic circuit	
	Flow switch is blocked	 Check the flow switch	
E06 Compressor discharge temperature fault	Compressor discharge temperature too high	Call a qualified technician	<ul style="list-style-type: none"> • «Steady red» LED = automatic • «Flashing red» LED = press 
E07 ST1 sensor fault - water inlet sensor	Sensor is faulty or offline	 Reconnect or change the sensor	By electricity supply disconnection or automatic if the fault disappears
E08 ST4 sensor fault - fluid line sensor	Sensor is faulty or offline	 Reconnect or change the sensor	By electricity supply disconnection or automatic if the fault disappears
E09 ST3 sensor fault - Defrost sensor	Sensor is faulty or offline	 Reconnect or change the sensor	By electricity supply disconnection or automatic if the fault disappears
E10 ST2 sensor fault - air inlet sensor	Sensor is faulty or offline	 Reconnect or change the sensor	By electricity supply disconnection or automatic if the fault disappears

 ST5 sensor fault - compressor discharge sensor	Sensor is faulty or offline	 Reconnect or change the sensor	By electricity supply disconnection or automatic if the fault disappears
 Communication fault between the regulation board and the display board	Bad connection between the boards	 Check the connectors on the link cable between the boards	<ul style="list-style-type: none"> • «Steady red» LED = automatic • «Flashing red» LED = press 
	Board power supply fault	 Check the boards' power supply	
	Faulty boards	 Replace the boards	

4.3 I Lighting of LEDs on the printed circuit board

	LED1	LED2	LED3	LED4	LED5
No errors Appliance switched off					●
No errors Appliance in operation				●	●
Error 01	●	○			
Error 02	●		○		
Error 03	●	○	○		
Error 04	●			○	
Error 05	●	○		○	
Error 06	●		○	○	
Error 07	●	○	○	○	
Error 08	●				○
Error 09	●	○			○
Error 10	●		○		○
Error 11	●	○	○		○
Error 12	●			○	○
Error 13	●	○		○	○

- : LED steadily lit
- : LED flashing
- Empty: LED off

4.4 I Wiring diagrams

4.4.1 Z400 iQ MD4 - MD5 - MD7 - MD8

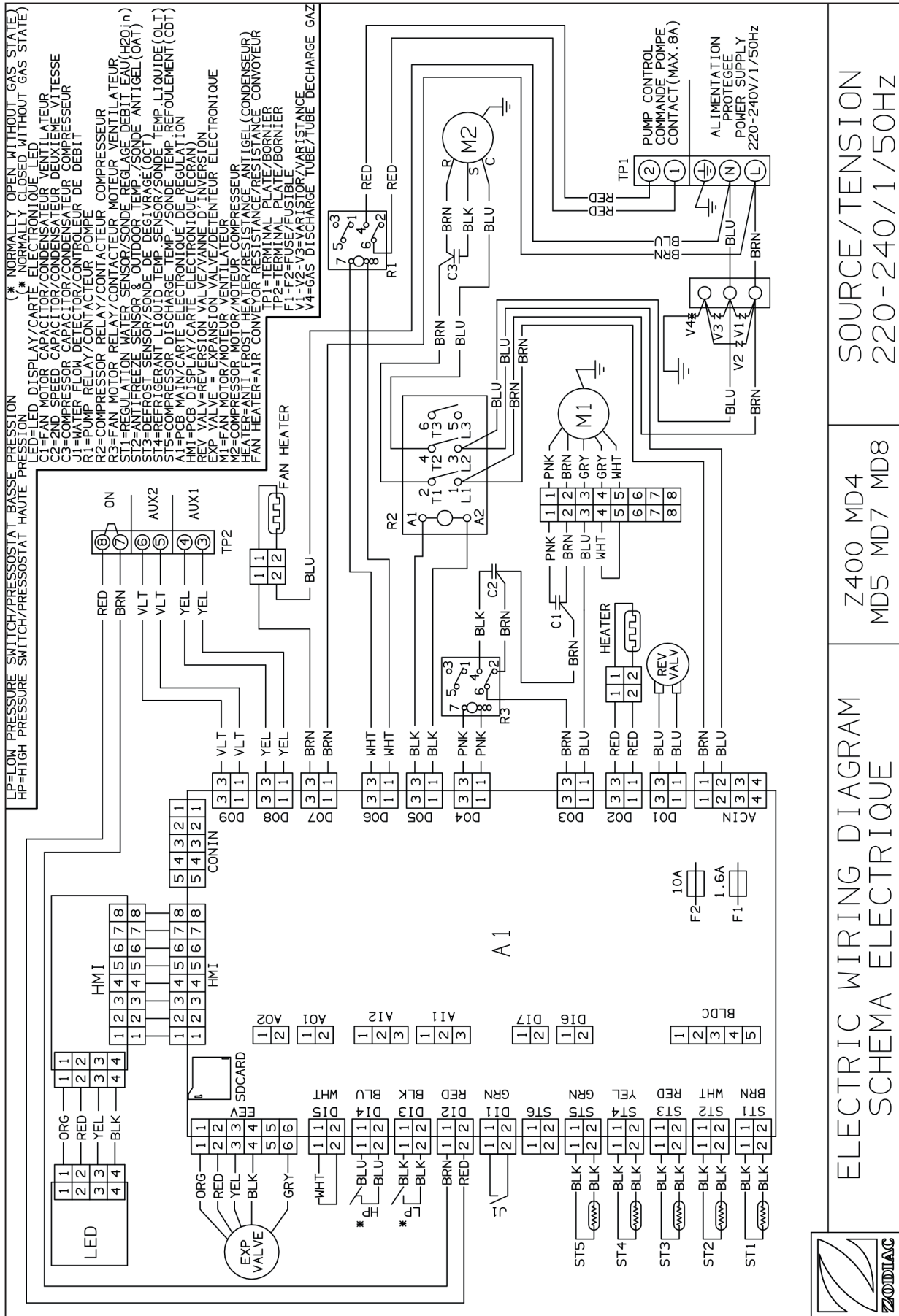

EN

4.4.2 Z400 iQ MD9

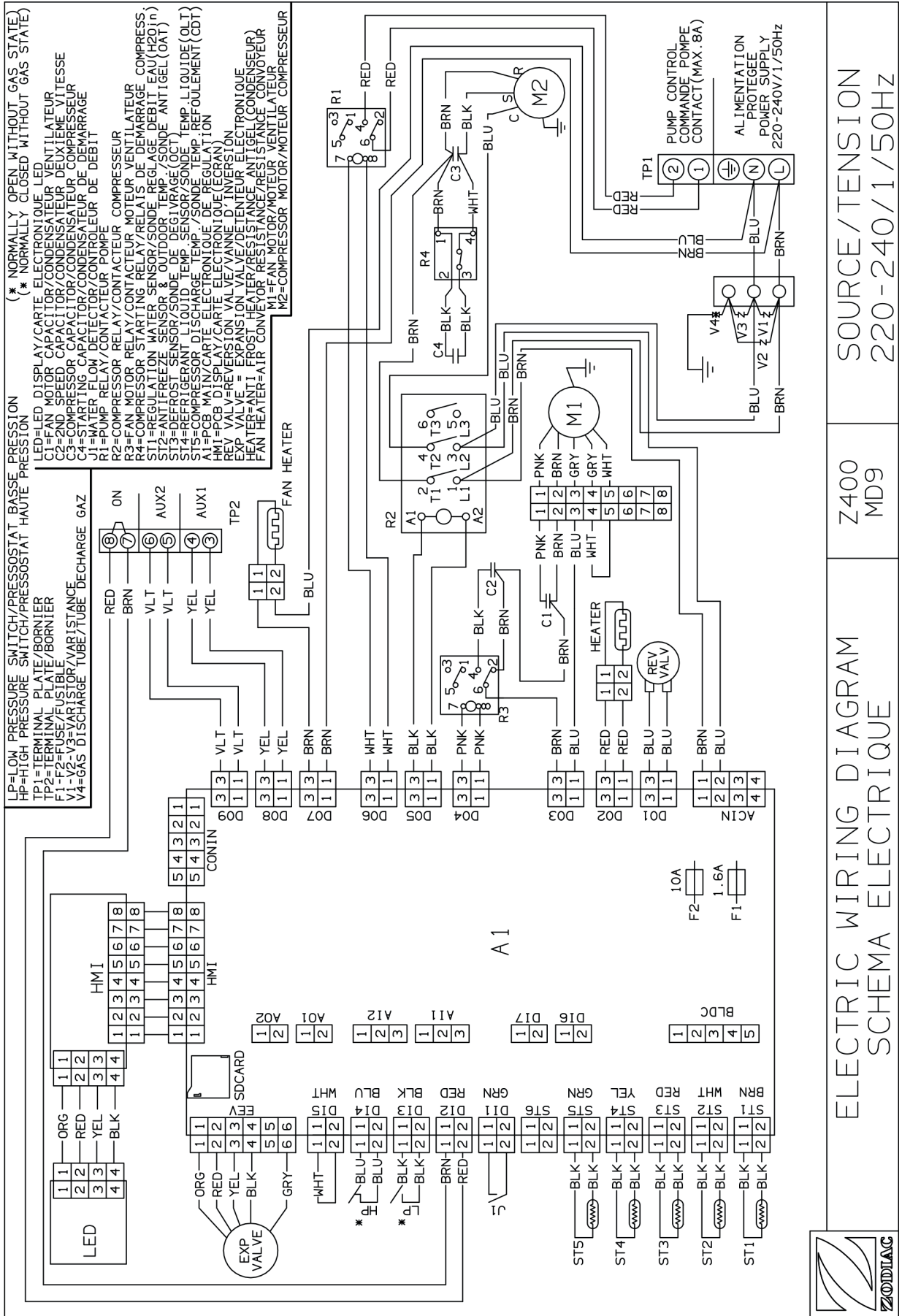

SOURCE/TENSION
220-240/1/50HZ

Z400
MD9

ELECTRIC WIRING DIAGRAM
SCHEMA ELECTRIQUE



4.4.3 Z400 iQ TD7 - TD8 - TD9

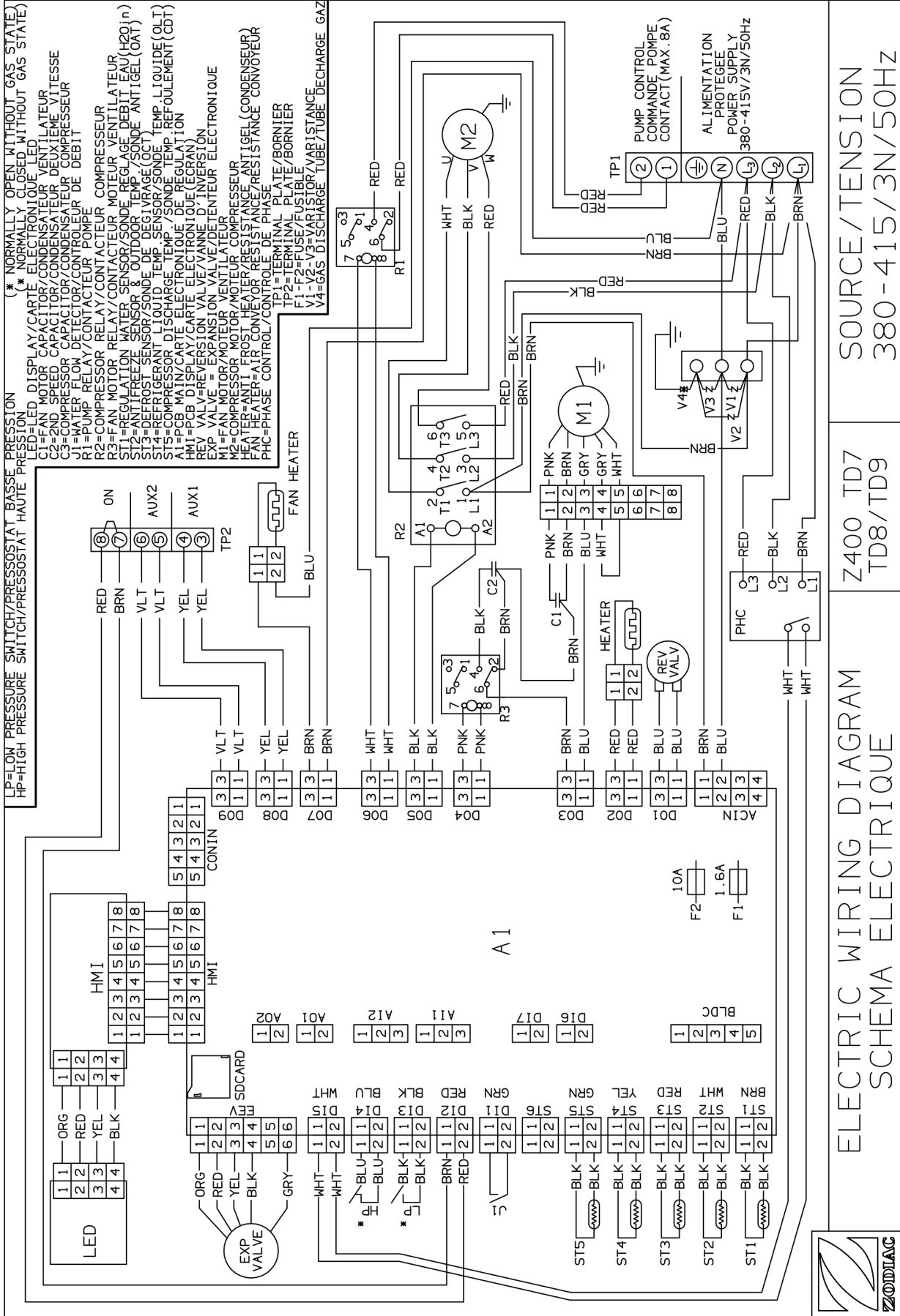

SOURCE / TENSION
380 - 415 / 3N / 50HZ

Z400 TD7
TD8 / TD9

ELECTRIC WIRING DIAGRAM
SCHEMA ELECTRIQUE



Symbol	Designation
A1	PCB main
HMI	PCB display
LED	Led display
C1	Fan motor capacitor
C2	2 nd speed capacitor
C3	Compressor capacitor
J1	Water flow detector
R1	Pump relay
R2	Compressor relay
R3	Fan motor relay
ST1	Regulation water sensor
ST2	Antifeeze sensor & outdoor temperature
ST3	Defrost sensor
ST4	Refrigerant liquid temperature sensor
ST5	Compressor discharge temperature
LP	Low pressure switch
HP	High pressure switch
REV VALV	Reversion valve
EXP VALVE	Expansion valve
M1	Fan motor
M2	Compressor motor
HEATER	Anti frost heater
FAN HEATER	Air conveyor resistance
TP1	Terminal plate
TP2	Terminal plate
F1 - F2	Fuse
V1 - V2	Varistor
V4	Gas discharge tube
RED	Red
BLK	Black
VLT	Violet
BLU	Blue
WHT	White
GRN/YEL	Green-Yellow
YEL	Yellow
BRN	Brown
PNK	Pink
ORG	Orange



5 Characteristics

5.1 I Description

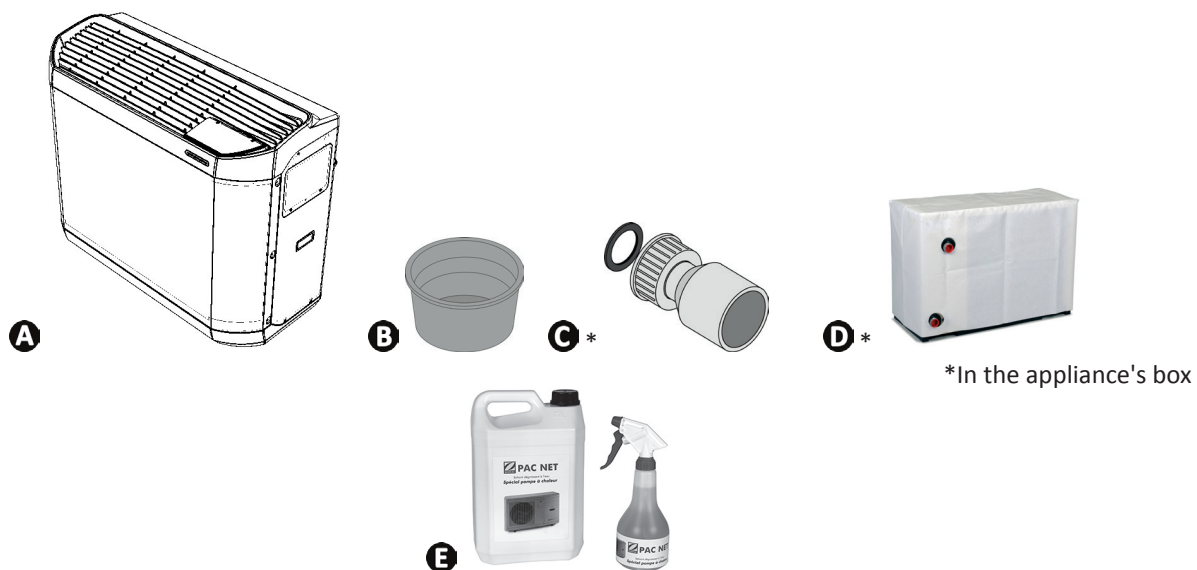

*In the appliance's box

EN

A		Z400 iQ
B	Winterizing cap (x2)	✓
C	∅50 connector to be glued (x2)	✓
D	Winterizing cover	✓
	Heating priority	✓
E	PAC NET (cleaning product)	+

✓ : supplied

⊕ : available as an accessory

5.2 I Technical specifications

Z400 iQ		MD4	MD5	MD7	TD7	MD8	TD8	MD9	TD9
Operating temperatures	air	-12 to 40 °C			-12 to 38 °C		-12 to 35 °C		
	water	10 to 32 °C							
Defrosting by forced air circulation		T°C air > to 10 °C							
Defrosting by cycle inversion		T°C air < to 10 °C							
Voltage		230V / 1 / 50 Hz		400V / 3 / 50 Hz	230V / 1 / 50 Hz	400V / 3 / 50 Hz	230V / 1 / 50 Hz	400V / 3 / 50 Hz	400V / 3 / 50 Hz
Admissible variation in voltage		± 10 %							
Pollution class		I							
Pollution degree		2							
Overvoltage category		II							
Nominal absorbed intensity	A	6.9	10.2	13.4	6.7	17	6.8	19.4	8.2
Maximum current input	A	10	15	19	8	28	10	32	12
Minimum cable section*	mm ²	3x1	3X1.5	3x2.5	5x1	3x4	5x1	3x4	5x1.5
		3G1	3G1.5	3G2.4	5G1	3G4	5G1	3G4	5G1.5
Proof pressure	bar	3							
Service pressure	bar	1,5							
Head loss	mCE	1,4	1,5	1,5	1,5	1,1	1,1	1,1	1,1
Medium water flow	m ³ /h	4	5	6		7		8	
Sound pressure (db(A))	Boost	64	65	66	68	≤ 70	≤ 70	≤ 70	≤ 70
	Silence	61	63	63	66	≤ 70	≤ 70	≤ 70	≤ 70
Maximum impedance value (Zmax)	ohm	0.056	0.040	N/A	0.056	N/A	0.056	N/A	0.056
Approximate weight	kg	70	71	90	94	105	105	110	110

* Values provided for information purposes for a maximum length of 20 metres (calculation base: NFC 15-100), must be checked and adapted to the installation conditions and standards of the installation country.

- Maximum operating pressure of the refrigerant circuit: 4.2 MPa / 42 bar
- Minimum operating pressure of the refrigerant circuit: 0.05 MPa / 0.5 bar
- Maximum operating pressure of the water circuit: 0.3 MPa / 3 bar
- Minimum operating pressure of the water circuit: 0.05 MPa / 0.5 bar

5.3 I Dimensions and marking

Z400 iQ	MD4	MD5	MD7	TD7	MD8	TD8	MD9	TD9
A*	1030				1145			
B*	450				480			
C*	479				509			
D*	880			1027				

*Overall dimensions in mm

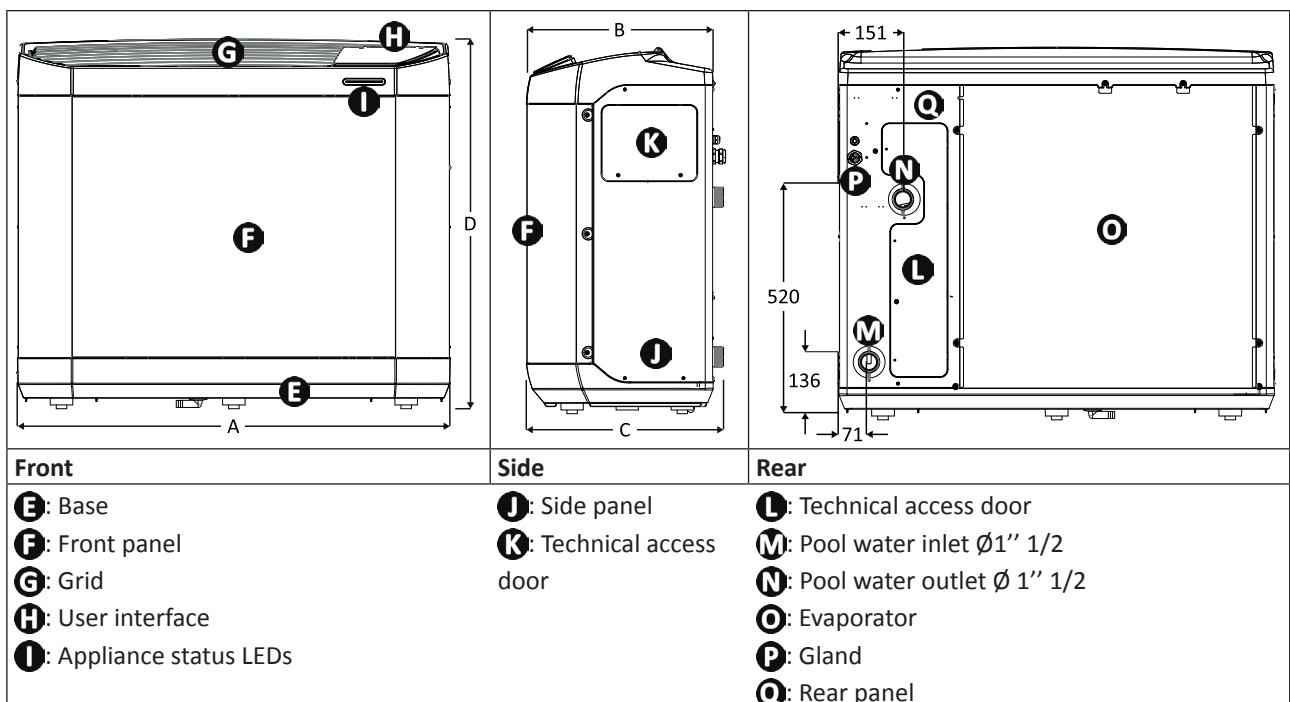

Votre revendeur
Your retailer

Modèle appareil
Appliance model

Numéro de série
Serial number

Pour plus d'informations, enregistrement produit et support client :
For more information, product registration and customer support:

www.zodiac.com

